



**USA HOSPITALITY**  
**BATH & FLOOR**



2025

# **PRODUCT** **CATALOGUE**

Your Path to Beautiful Flooring Begins Here.

[www.usahospitalitytn.com](http://www.usahospitalitytn.com)



# TABLE OF CONTENTS

<b>01. SPC Flooring</b> .....	<b>04-09</b>
<b>02. Loose Lay Flooring</b> .....	<b>10-11</b>
<b>03. Porcelain Surround</b> .....	<b>12-15</b>
<b>04. Porcelain Tiles</b> .....	<b>16-17</b>
<b>05. Cultured Marble Shower Panel</b> .....	<b>18-21</b>
<b>06. Cultured Marble Shower Pan</b> .....	<b>24-29</b>
<b>07. Regular Shower Pan</b> .....	<b>30</b>
<b>08. Roll-in Shower Pan</b> .....	<b>31</b>
<b>09. Accessories - Trim</b> .....	<b>32</b>
<b>10. Accessories - Foot Rest</b> .....	<b>33-34</b>
<b>11. Accessories - Shampoo Dish</b> .....	<b>35-36</b>
<b>12. Glass Door</b> .....	<b>37</b>
<b>13. Faucet</b> .....	<b>38-43</b>
<b>14. Accessories</b> .....	<b>44-55</b>

# SPC FLOORING

## Antique Oak

### Construction

Color name : Antique Oak

Color code : USA22235

Size : 1220\*182mm

Thickness : 6MMSPC+1.5MMIXPE

Wear Layer : 20mil

Pcs per Pack : 6pcs

Quantity Per Pack : 14.3401SQ.FT



### Specification Sheet Result

Classification : 42

Density : 2.03 - 2.05g/cm<sup>3</sup>

Peel Strength : 2.8Kgf/2cm

Chemical Resistance : Pass

Color fitness to : Pass. ≥ Grade 6

Artificial Light

Castor Chair Suitability : Pass Type W

Residual Indentation : Pass. ≤ 0.1mm

### Specification Sheet Result

Abrasion Group : Group T

Dimensional Stability : Pass 0.1%

Curling : ≤ 2 mm

Sound Reduction : 2 db

Slip Resistance : R10 class DS

Electrical Resistance : Pass

Thermal Resistance : Pass 0.038m<sup>2</sup>K/V

Fungus Resistance : No Growth

Behavior to Fire : Bfl - S1

## Technical Specifications



Pet & Family  
Friendly



Scratch & Dent  
Resistant



Waterproof



Easy  
Installation



4-Seasons



Comfortable  
& Quiet



# SPC FLOORING

## Classic Oak

### Construction

Color name	: Classic Oak
Color code	: USA22236
Size	: 1220*182mm
Thickness	: 6MMSPC+1.5MMIXPE
Wear Layer	: 20mil
Pcs per Pack	: 6pcs
Quantity Per Pack	: 14.3401SQ.FT



### Specification Sheet Result

Classification	: 42
Density	: 2.03 - 2.05g/cm <sup>3</sup>
Peel Strength	: 2.8Kgf/2cm
Chemical Resistance	: Pass
Color fitness to	: Pass.≥ Grade 6
Artificial Light	
Castor Chair Suitability	: Pass Type W
Residual Indentation	: Pass.≤0.1mm

### Specification Sheet Result

Abrasion Group	: Group T
Dimensional Stability	: Pass 0.1%
Curling	: ≤2 mm
Sound Reduction	: 2 db
Slip Resistance	: R10 class DS
Electrical Resistance	: Pass
Thermal Resistance	: Pass 0.038m <sup>2</sup> K/V
Fungus Resistance	: No Growth
Behavior to Fire	: Bfl - S1

## Technical Specifications



Pet & Family  
Friendly



Scratch & Dent  
Resistant



Waterproof



Easy  
Installation



4-Seasons



Comfortable  
& Quiet

# SPC FLOORING

## Charming Oak

### Construction

Color name : Charming Oak

Color code : USA22243

Size : 1220\*182mm

Thickness : 6MMSPC+1.5MMIXPE

Wear Layer : 20mil

Pcs per Pack : 6pcs

Quantity Per Pack : 14.3401SQ.FT



### Specification Sheet Result

Classification : 42

Density : 2.03 - 2.05g/cm<sup>3</sup>

Peel Strength : 2.8Kgf/2cm

Chemical Resistance : Pass

Color fitness to : Pass. ≥ Grade 6

Artificial Light

Castor Chair Suitability : Pass Type W

Residual Indentation : Pass. ≤ 0.1mm

### Specification Sheet Result

Abrasion Group : Group T

Dimensional Stability : Pass 0.1%

Curling : ≤ 2 mm

Sound Reduction : 2 db

Slip Resistance : R10 class DS

Electrical Resistance : Pass

Thermal Resistance : Pass 0.038m<sup>2</sup>K/V

Fungus Resistance : No Growth

Behavior to Fire : Bfl - S1

## Technical Specifications



Pet & Family  
Friendly



Scratch & Dent  
Resistant



Waterproof



Easy  
Installation



4-Seasons



Comfortable  
& Quiet

# SPC FLOORING

## Elegant Oak

### Construction

Color name : Elegant Oak

Color code : USA22244

Size : 1220\*182mm

Thickness : 6MMSPC+1.5MMIXPE

Wear Layer : 20mil

Pcs per Pack : 6pcs

Quantity Per Pack : 14.3401SQ.FT



### Specification Sheet Result

Classification	: 42
Density	: 2.03 - 2.05g/cm <sup>3</sup>
Peel Strength	: 2.8Kgf/2cm
Chemical Resistance	: Pass
Color fitness to	: Pass.≥ Grade 6
Artificial Light	
Castor Chair Suitability	: Pass Type W
Residual Indentation	: Pass.≤0.1mm

### Specification Sheet Result

Abrasion Group	: Group T
Dimensional Stability	: Pass 0.1%
Curling	: ≤2 mm
Sound Reduction	: 2 db
Slip Resistance	: R10 class DS
Electrical Resistance	: Pass
Thermal Resistance	: Pass 0.038m2K/V
Fungus Resistance	: No Growth
Behavior to Fire	: Bfl - S1

## Technical Specifications



Pet & Family  
Friendly



Scratch & Dent  
Resistant



Waterproof



Easy  
Installation



4-Seasons



Comfortable  
& Quiet



# SPC FLOORING

## Wild Oak

### Construction

Color name	: Wild Oak
Color code	: USA22258
Size	: 1220*182mm
Thickness	: 6MMSPC+1.5MMIXPE
Wear Layer	: 20mil
Pcs per Pack	: 6pcs
Quantity Per Pack	: 14.3401SQ.FT



### Specification Sheet Result

Classification	: 42
Density	: 2.03 - 2.05g/cm <sup>3</sup>
Peel Strength	: 2.8Kgf/2cm
Chemical Resistance	: Pass
Color fitness to	: Pass. ≥ Grade 6
Artificial Light	
Castor Chair Suitability	: Pass Type W
Residual Indentation	: Pass. ≤ 0.1mm

### Specification Sheet Result

Abrasion Group	: Group T
Dimensional Stability	: Pass 0.1%
Curling	: ≤ 2 mm
Sound Reduction	: 2 db
Slip Resistance	: R10 class DS
Electrical Resistance	: Pass
Thermal Resistance	: Pass 0.038m <sup>2</sup> K/V
Fungus Resistance	: No Growth
Behavior to Fire	: Bfl - S1

## Technical Specifications



Pet & Family  
Friendly



Scratch & Dent  
Resistant



Waterproof



Easy  
Installation



4-Seasons



Comfortable  
& Quiet



# SPC FLOORING

## Modern Oak

### Construction

Color name	: Modern Oak
Color code	: USA22259
Size	: 1220*182mm
Thickness	: 6MMSPC+1.5MMIXPE
Wear Layer	: 20mil
Pcs per Pack	: 6pcs
Quantity Per Pack	: 14.3401SQ.FT



### Specification Sheet Result

Classification	: 42
Density	: 2.03 - 2.05g/cm <sup>3</sup>
Peel Strength	: 2.8Kgf/2cm
Chemical Resistance	: Pass
Color fitness to	: Pass. ≥ Grade 6
Artificial Light	
Castor Chair Suitability	: Pass Type W
Residual Indentation	: Pass. ≤ 0.1mm

### Specification Sheet Result

Abrasion Group	: Group T
Dimensional Stability	: Pass 0.1%
Curling	: ≤ 2 mm
Sound Reduction	: 2 db
Slip Resistance	: R10 class DS
Electrical Resistance	: Pass
Thermal Resistance	: Pass 0.038m <sup>2</sup> K/V
Fungus Resistance	: No Growth
Behavior to Fire	: Bfl - S1

## Technical Specifications



Pet & Family  
Friendly



Scratch & Dent  
Resistant



Waterproof



Easy  
Installation



4-Seasons



Comfortable  
& Quiet

# LOOSE LAY FLOORING

## Charming Oak

### Construction

Color name	: Charming Oak
Color code	: USA22243
Size	: 1219.2*177.8mm
Thickness	: 5MM Loose lay
Wear Layer	: 20mil
Pcs per Pack	: 12pcs
Quantity Per Pack	: 28.002SQ.FT



### Specification Sheet Result

Classification	: 42
Density	: 1.95-2.00g/ cm <sup>3</sup>
Peel Strength	: 2.8Kgf/2cm
Chemical Resistance	: Pass
Color fitness to	: Pass.≥ Grade 6
Artificial Light	
Castor Chair Suitability	: Pass Type W
Residual Indentation	: Pass.≤0.1mm

### Specification Sheet Result

Abrasion Group	: Group T
Dimensional Stability	: Pass 0.1%
Curling	: ≤2 mm
Sound Reduction	: 2 db
Slip Resistance	: R10 class DS
Electrical Resistance	: Pass
Thermal Resistance	: Pass 0.038m2K/V
Fungus Resistance	: No Growth
Behavior to Fire	: Bfl - S1

## Technical Specifications



Pet & Family  
Friendly



Scratch & Dent  
Resistant



Waterproof



Easy  
Installation



4-Seasons



Comfortable  
& Quiet

# LOOSE LAY FLOORING

## Wild Oak

### Construction

Color name	: Wild Oak
Color code	: USA22258
Size	: 1219.2*177.8mm
Thickness	: 5MM Loose lay
Wear Layer	: 20mil
Pcs per Pack	: 12pcs
Quantity Per Pack	: 28.002SQ.FT



### Specification Sheet Result

Classification	: 42
Density	: 1.95-2.00g/ cm <sup>3</sup>
Peel Strength	: 2.8Kgf/2cm
Chemical Resistance	: Pass
Color fitness to	: Pass.≥ Grade 6
Artificial Light	
Castor Chair Suitability	: Pass Type W
Residual Indentation	: Pass.≤0.1mm

### Specification Sheet Result

Abrasion Group	: Group T
Dimensional Stability	: Pass 0.1%
Curling	: ≤2 mm
Sound Reduction	: 2 db
Slip Resistance	: R10 class DS
Electrical Resistance	: Pass
Thermal Resistance	: Pass 0.038m2K/V
Fungus Resistance	: No Growth
Behavior to Fire	: Bfl - S1

## Technical Specifications



Pet & Family  
Friendly



Scratch & Dent  
Resistant



Waterproof



Easy  
Installation



4-Seasons



Comfortable  
& Quiet





## PORCELAIN SURROUND

Design Name : Statuario Rhyme  
 Design Variation : Random Design  
 Size : 32 x 32 inch  
 Finish : Glossy

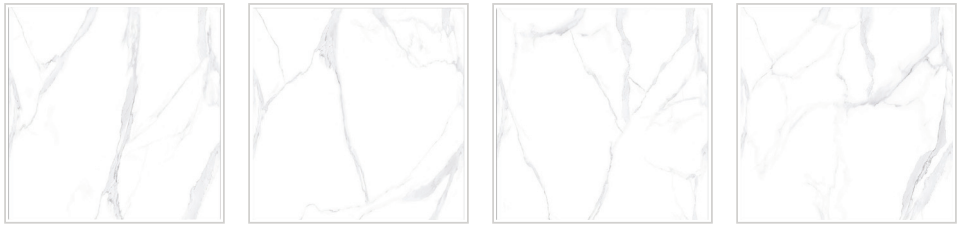

Design Name : Statuario Rhyme  
 Design Variation : Random Design  
 Size : 32 x 63 inch  
 Finish : Glossy

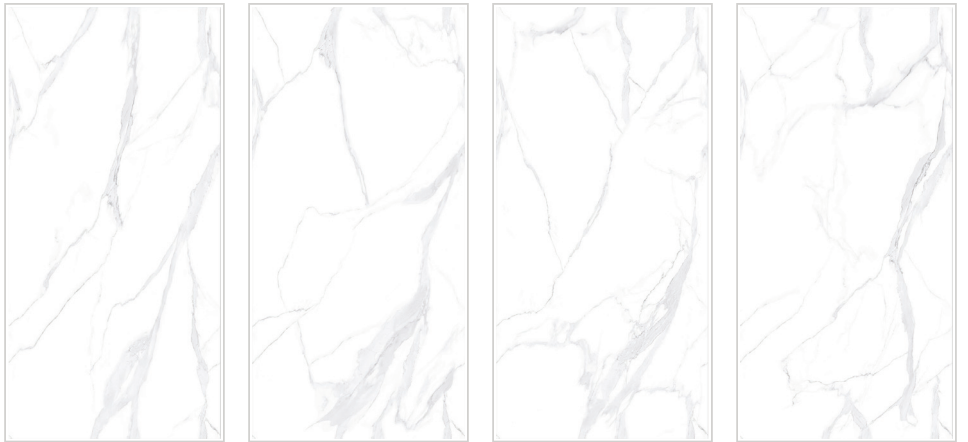

## Technical Specifications



Heat  
Resistant



Frost  
Resistant



Easy  
to Clean



Scratch  
Proof



ACID  
Resistant





## PORCELAIN SURROUND

Design Name	: Tora White
Design Variation	: Random Design
Size	: 32 x 32 inch
Finish	: Glossy

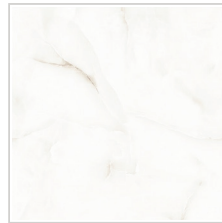
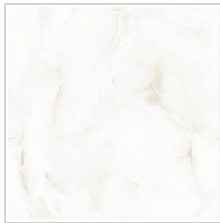

Design Name	: Tora White
Design Variation	: Random Design
Size	: 32 x 63 inch
Finish	: Glossy

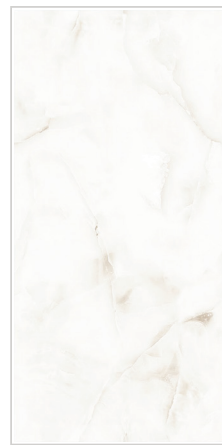
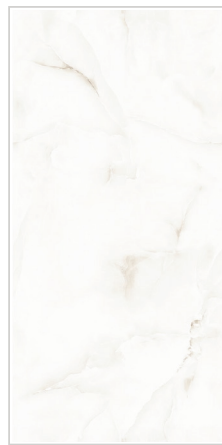
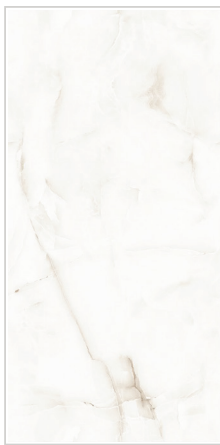

## Technical Specifications



Heat  
Resistant



Frost  
Resistant



Easy  
to Clean



Scratch  
Proof



ACID  
Resistant



## PORCELAIN SURROUND

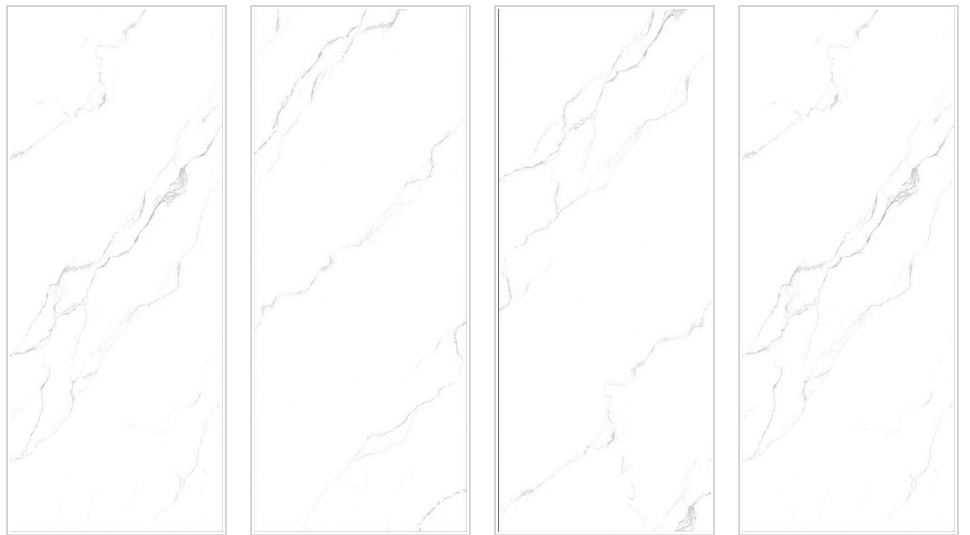

Design Name : Statuario Wind

Design Variation : Random Design

Size : 32 x 72 inch

Finish : Glossy

## Technical Specifications



Heat  
Resistant



Frost  
Resistant



Easy  
to Clean



Scratch  
Proof



ACID  
Resistant



## PORCELAIN SURROUND



Design Name	: Grisial Gray
Design Variation	: Random Design
Size	: 32 x 72 inch
Finish	: Glossy

### Technical Specifications



Heat  
Resistant



Frost  
Resistant



Easy  
to Clean



Scratch  
Proof



ACID  
Resistant



## PORCELAIN TILES

Size	: 12 x 24 inch
Finish	: Matte

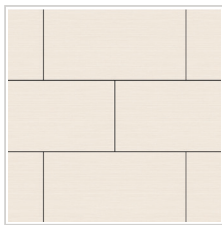

Rioja P2



Rioja P3



Rioja P4



Rioja P5

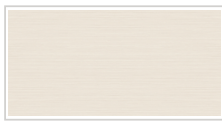

## Technical Specifications



Stain  
Resistant



Exclusive Natural  
Wooden Textures



Super  
Flatness



HD  
Clarity



Low  
Maintenance



High Body  
Strength





# PORCELAIN TILES

## Application

We have landed Habitat, a proposal entirely dedicated to All Habitual Spaces. An evolution capable of giving shape and design to Urban Areas with a strong architectural presence from Interior to Exterior coverings and floors and Heavy Duty, High Traffic areas such as malls, airports & Shops.

Size	: 8 x 48 inch
Finish	: Matte



Celtis Wood



Fire Wood



Repal Junk

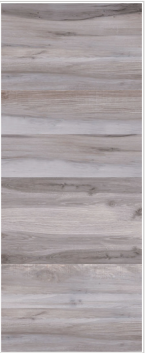

Roar Gray



Tera Wood Gray



Latte Wood

## Technical Specifications



Stain Resistant



Exclusive Natural Wooden Textures



Super Flatness



HD Clarity



Low Maintenance



High Body Strength

# CULTURED MARBLE SHOWER PANEL

## S-DL-6X24

### Applications

Tub and Shower Surrounds

Hospitality | Multifamily | Senior Living |

Student Housing | Military Housing

Colors : **Customized Colors available\***



### Standard Features

- 6" X 24" smooth block pattern
- 2" integral accent bands
- solid one piece groutless panels
- Permanently sealed surface
- Will not mold or mildew
- Oversized - measure , cut and fit on jobsite
- Easy to Install
- Easy to Maintain

### Technical Specifications

Model	: 6" X 24" Bordeaux
Pattern	: Smooth, stacked blocks, pattern with integral bands
Material	: Cast Marble
Panel Widths	: 32" - designated left and right 36" - designated left and right 62" - designated right
Height	: Up to 96" max
Thickness	: 1/4"
Finish	: Matte/Gloss

# CULTURED MARBLE SHOWER PANEL

## TS-EV-3x8 Chevron

### Applications

Tub and Shower Surrounds  
Hospitality | Multifamily | Senior Living |  
Student Housing | Military Housing

Colors : **White**

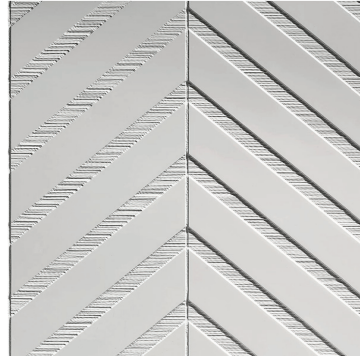

### Standard Features

- Alternating smooth and textured Chevron pattern
- Solid one-piece groutless panels
- Permanently sealed surface
- Will not mold or mildew
- Oversized - measure, cut and fit on jobsite
- Easy to install
- Easy to maintain

### Technical Specifications

Model	: 3" x 8" Chevron
Pattern	: Chevron
Material	: Cast Marble
Panel Widths	: 32" - designated left and right 36" - designated left and right 42" 62"
Height	: 96" max
Thickness	: 1/4"
Finish	: Textured Matte and Gloss
CSI NUMBER	: 06 61 13



# CULTURED MARBLE SHOWER PANEL

## TS-CS-4x15 Chevron

### Applications

Tub and Shower Surrounds  
Hospitality | Multifamily | Senior Living |  
Student Housing | Military Housing

Colors : **White**

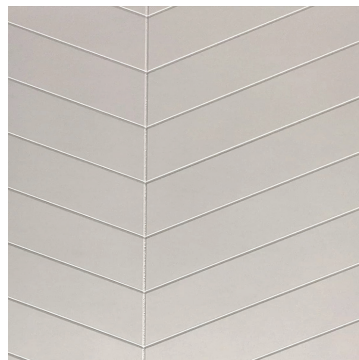

### Standard Features

- Chevron pattern
- Solid one-piece groutless panels
- Permanently sealed surface
- Will not mold or mildew
- Oversized – measure, cut, and fit on job site
- Easy to install
- Easy to maintain
- Manufactured in the U.S.A.

### Technical Specifications

Model	: 4" x 15" Chevron
Pattern	: Chevron
Material	: Cast Marble
Panel Widths	: 32" Reversible 36" Reversible 48" 62"
Height	: 96" max
Thickness	: 1/4"
Finish	: Matte
CSI NUMBER	: 06 61 13



# CULTURED MARBLE SHOWER PANEL

## TS-VS-6x24 Stacked-IL-Dim

### Applications

Tub and Shower Surrounds  
 Hospitality | Multifamily | Senior Living |  
 Student Housing | Military Housing

Colors : **Customized Colors available\***



### Standard Features

- 6" x 24" textured stacked block pattern
- 6" integral dimensions listello
- Solid one-piece groutless panels
- Permanently sealed surface
- Will not mold or mildew
- Oversized - measure, cut and fit on jobsite
- Easy to install
- Easy to maintain
- Manufactured in the U.S.A.

### Technical Specifications

Model	: 6" x 24" Stacked Dimensions
Pattern	: Textured stacked block pattern with integral 6" dimensions listello
Material	: Cast Marble
Panel Widths	: 30" Designated left and right 36" Designated left and right 60" 72" Split back panel
Height	: 30", 36" and 60" - up to 96" max, 72" split - 60" and 36"
Thickness	: 1/4"
Finish	: Textured Matte
CSI Number	: 06 61 13

# CULTURED MARBLE SHOWER PANEL

## TS-VS-6x24 Vision

### Applications

Tub and Shower Surrounds

Hospitality | Multifamily | Senior Living |

Student Housing | Military Housing

Colors : **Customized Colors available\***



### Standard Features

- 6" x 24" staggered block pattern
- Solid one-piece groutless panels
- Permanently sealed surface
- Extremely sanitary
- Will not mold or mildew
- Oversized - measure, cut and fit on jobsite
- Easy to install
- Easy to maintain
- Manufactured in the U.S.A.

### Technical Specifications

Model	: 6" x 24" Vision
Pattern	: Textured staggered block pattern
Material	: Cast Marble
Panel Widths	: 30" - designated left and right 32" - designated left and right 36" - designated left and right 48" 62" 96"
Height	: 30", 36", 48" and 62" - up to 96" H 96" - up to 60" H
Thickness	: 1/4"
Finish	: Textured Matte
CSI Number	: 06 61 13

# CULTURED MARBLE SHOWER PANEL

## TS-VS: Vertical Vision

### Applications

Tub and Shower Surrounds

Hospitality | Multifamily | Senior Living |

Student Housing | Military Housing

Colors : **Customized Colors available\***

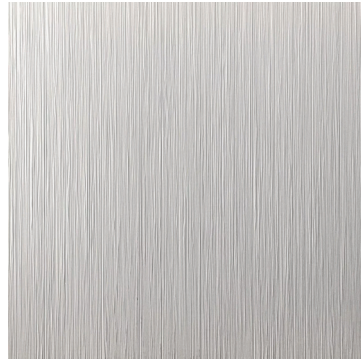

### Standard Features

- Vertical textured lines pattern
- Solid one-piece groutless panels
- Permanently sealed surface
- Extremely sanitary
- Will not mold or mildew
- Oversized - measure, cut and fit on jobsite
- Easy to install
- Easy to maintain
- Manufactured in the U.S.A.

### Technical Specifications

Model	: Vertical Vision
Pattern	: Vertical textured panel pattern
Material	: Cast Marble
Panel Widths	: 22" 30" - reversible 36" - reversible 50" 60"
Height	: Up to 95" max
Thickness	: 1/4"
Finish	: Textured Matte
CSI Number	: 06 61 13



# CULTURED MARBLE SHOWER PAN

## TD - 3060 - OS4

### Applications

Hospitality | Multifamily | Senior Living |  
Student Housing | Military Housing

Colors : Customized Colors available\*

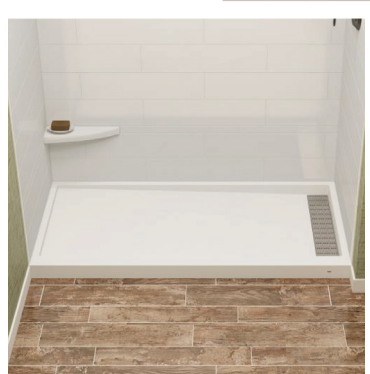

### Technical Specifications

Model	: Trench Drain
Special Feature	: Designed to fit the footprint of a tub
Pan Size	: 30" X 60"
Floor Pattern	: Traditional
Material	: Cultured Marble
Panel Widths	: 32" - designated left and right 36" - designated left and right 62" - designated right
Height	: Up to 96" max
Thickness	: 1/4"
Finish	: Matte , Textured, Non-slip
Backwall	: 59 7/8"
Side Walls	: 30"

### Technical Specifications

DRAIN Location	: Offset -(specify left or right)
Center of	: 14" 1/4" from backwall,
Drain Measures	4" from side wall
Dimensions	: Note- Finished Product Dimensions may vary +/- 1/8" from drawings
Drain Opening	: 3 1/4"
Trench Width	: 5"
Drain Cover	: 25"
FrontCurb	: Integral , 3" w x 4" h
Flange	: 1" on side and blackwalls - integrated molding at factory
Weight	: -175#

# CULTURED MARBLE SHOWER PAN

**TD - 3060 - OS4**

## Applications

Hospitality | Multifamily | Senior Living |  
Student Housing | Military Housing

Colors : Customized Colors available\*

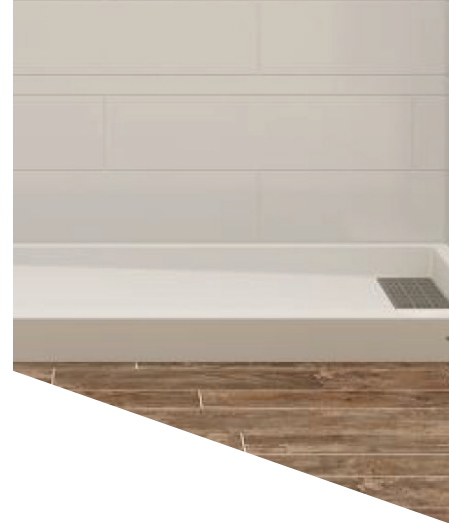
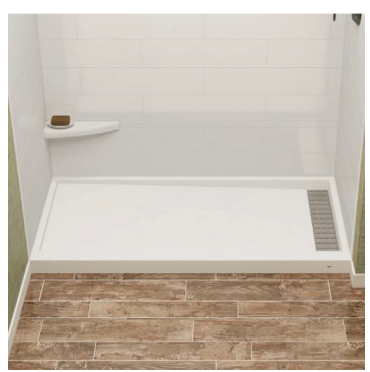

## Standard Features

- Solid one piece cast marble
- Durable get coat surface
- Pre-leveled-rests on subfloor
- Extremely sanitary
- Will not mold or mildew
- Easy to install
- Maintenance free
- Trench drain with removable cover for easy cleaning
- Recommended add Shower Pan Liners to protect pans during construction

TD-3060(4")-OS/SF-L

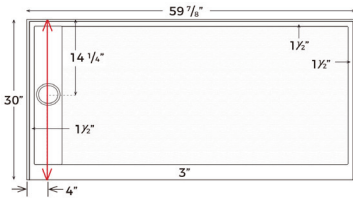

Finished product dimensions may vary by +/- 1/8" from drawings.

TD-3060(4")-OS/SF-R

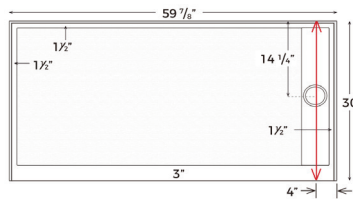

Finished product dimensions may vary by +/- 1/8" from drawings.

1" Flange integrated molding at factory on Back & Sides



Integral Curb 3" Tall

Left Hand Drain Shown. Left & Right Hand Drain Available.

### Drain Cover



### Drain Details

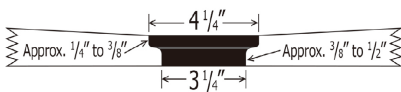

### Section Detail

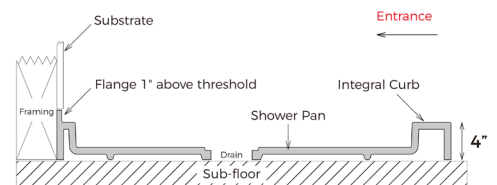

# CULTURED MARBLE SHOWER PAN

**TD - 3460 - OS4**

## Applications

Hospitality | Multifamily | Senior Living |  
Student Housing | Military Housing

Colors : Customized Colors available\*

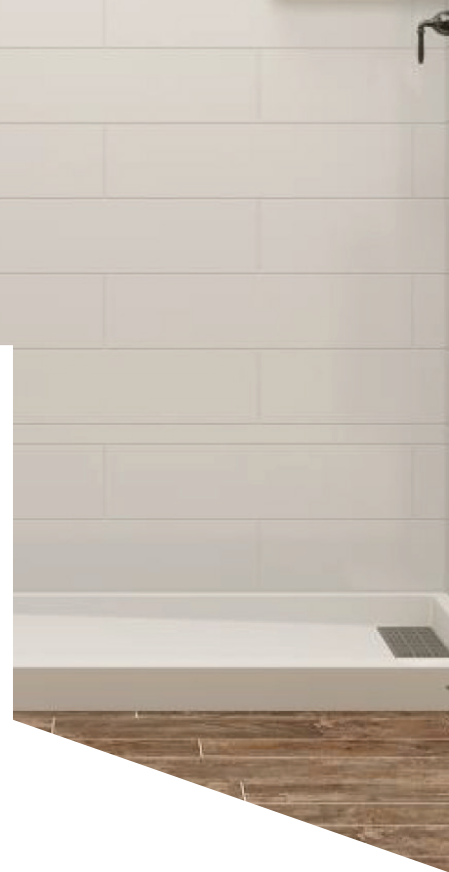

## Technical Specifications

Model	: Trench Drain
Special Feature	: Designed to fit the footprint of a tub
Pan Size	: 34"x60"
Material	: Culture Marble
Floor Pattern	: Traditional
Finish	: Matte, Textured, Non-Slip
Backwall	: 59 7/8"
Side Walls	: 34"
Drain Location	: Offset - (specify left or right)

## Technical Specifications

Center of Drain Measures	: 14 1/4" from backwall, 4" from side wall
Dimensions	: NOTE : Finished product dimensions may vary +/- 1/8" from drawings
Drain Opening	: 3 1/4"
Trench Width	: 5"
Drain Cover	: 25"
Front Curb	: Integral, 3"w x 4"h
Weight	: ~ 175#



# CULTURED MARBLE SHOWER PAN

**TD - 3460 - OS4**

## Applications

Hospitality | Multifamily | Senior Living |  
Student Housing | Military Housing

Colors : Customized Colors available\*

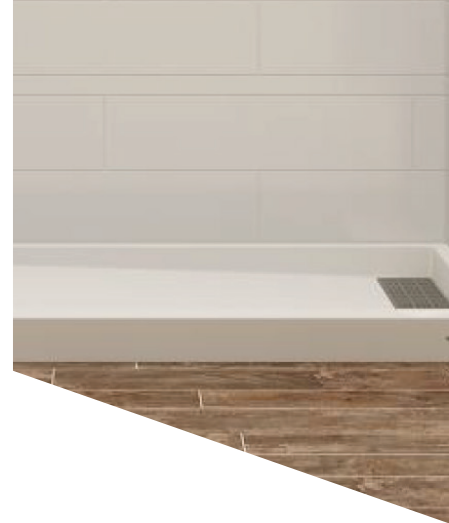
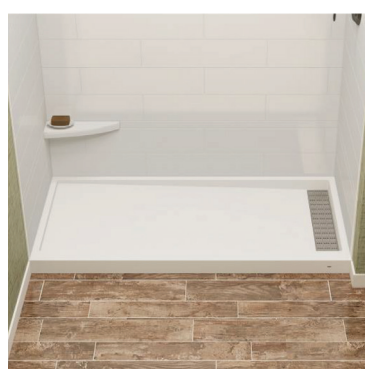

## Standard Features

- Solid one piece cast marble
- Durable get coat surface
- Pre-leveled-rests on subfloor
- Extremely sanitary
- Will not mold or mildew
- Easy to install
- Maintenance free
- Trench drain with removable cover for easy cleaning
- Recommended add Shower Pan Liners to protect pans during construction

TD-3460(4")-OS/SF-L

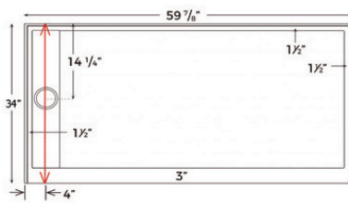

Finished product dimensions may vary by +/- 1/8" from drawings.

TD-3460(4")-OS/SF-R

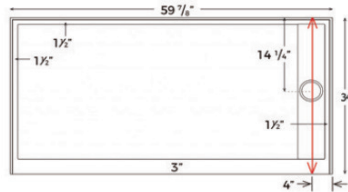

Finished product dimensions may vary by +/- 1/8" from drawings.

1" Flange integrated molding at factory on Back & Sides



Integral Curb 3" Tall

Left Hand Drain Shown. Left & Right Hand Drain Available.

### Drain Cover



### Drain Details

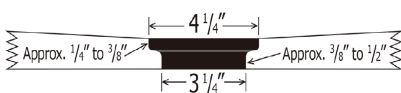

### Section Detail

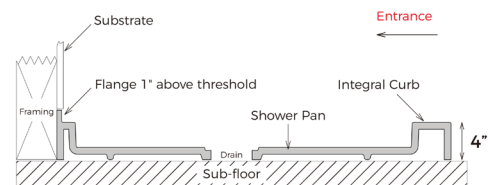

For an additional charge, Powder Coating options are available. Please contact our sales associates for more information.

# CULTURED MARBLE SHOWER PAN

## TD-3660-OS4

### Applications

Hospitality | Multifamily | Senior Living |  
Student Housing | Military Housing

Colors : Customized Colors available\*

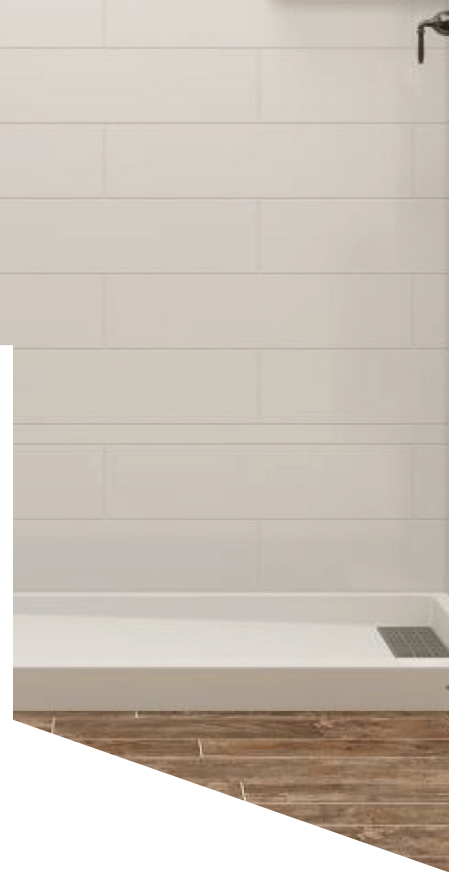
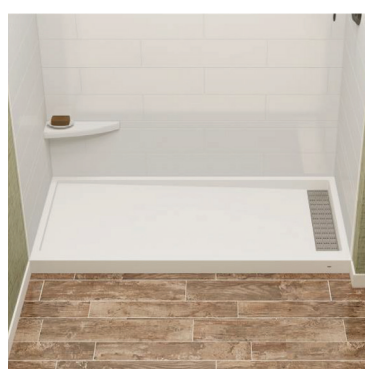

### Technical Specifications

Model	: Trench Drain
Special Feature	: Designed to fit the footprint of a tub
Pan Size	: 36"x60"
Material	: Culture Marble
Floor Pattern	: Traditional
Finish	: Matte, Textured, Non-Slip
Backwall	: 59 7/8"
Side Walls	: 36"
Drain Location	: Offset - (specify left or right)

### Technical Specifications

Center of Drain Measures	: 14 1/4" from backwall, 4" from side wall
Dimensions	: NOTE : Finished product dimensions may vary +/- 1/8" from drawings
Drain Opening	: 3 1/4"
Trench Width	: 5"
Drain Cover	: 25"
Front Curb	: Integral, 3"w x 4"h
Flange	: 1" on side and backwalls - integrated molding at factory
Weight	: ~ 175#

# CULTURED MARBLE SHOWER PAN

## TD-3660-OS4

### Applications

Hospitality | Multifamily | Senior Living |  
Student Housing | Military Housing

Colors : Customized Colors available\*

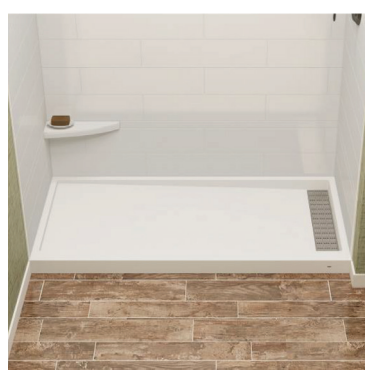

### Standard Features

- Solid one piece cast marble
- Durable get coat surface
- Pre-leveled-rests on subfloor
- Extremely sanitary
- Will not mold or mildew
- Easy to install
- Maintenance free
- Trench drain with removable cover for easy cleaning
- Recommended add Shower Pan Liners to protect pans during construction

TD-3660(4")-OS/SF-L

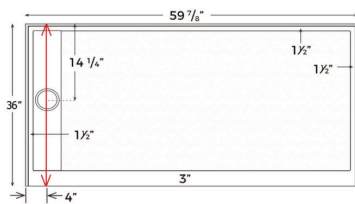

Finished product dimensions may vary by +/- 1/8" from drawings.

TD-3660(4")-OS/SF-R

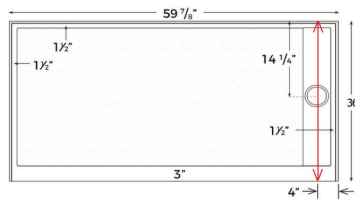

Finished product dimensions may vary by +/- 1/8" from drawings.

1" Flange integrated molding at factory on Back & Sides



Integral Curb 3" Tall

Left Hand Drain Shown. Left & Right Hand Drain Available.

### Drain Cover



### Drain Details

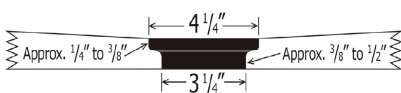

### Section Detail

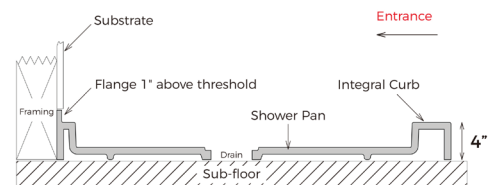

For an additional charge, Powder Coating options are available. Please contact our sales associates for more information.



# REGULAR SHOWER PAN

**60033897**

## Applications

Anti-slip finish at bottom



## Technical Specifications

Model	: Regular Shower Pan
Length	: 1520 mm
Tolerance	: $\pm 4$ mm
Min	: 1516 mm
Max	: 1524 mm

## Technical Specifications

Width	: 760 mm
Tolerance	: $\pm 2$ mm
Min	: 758 mm
Max	: 762 mm
Dimension	: $\pm 3$ mm

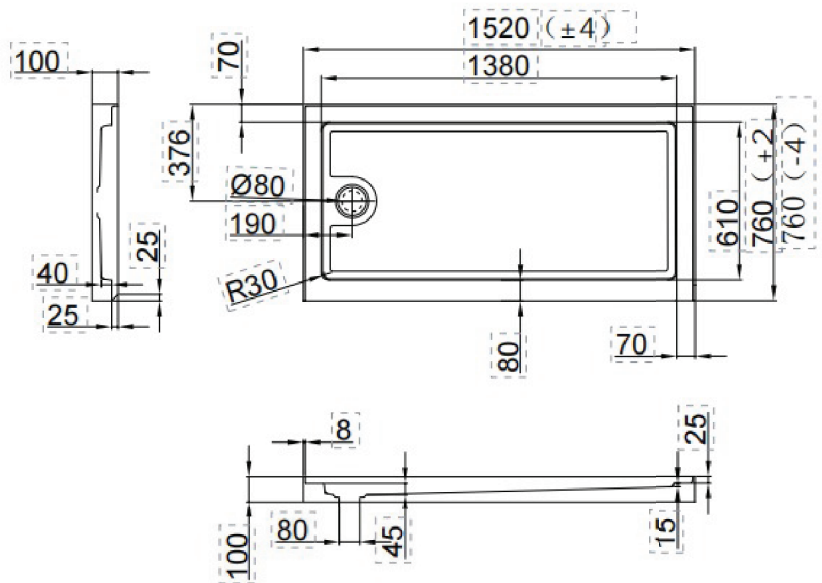
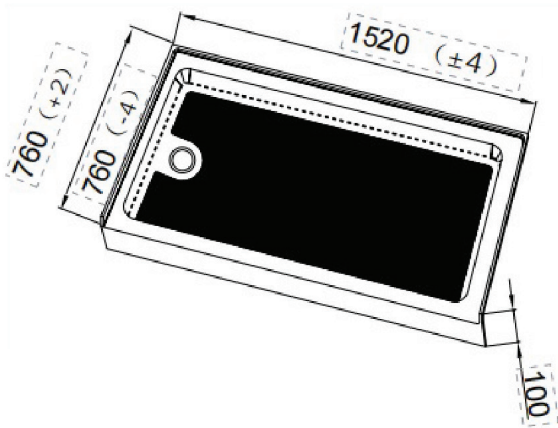

# ROLL-IN SHOWER PAN

## RI3060

### Applications

Hospitality | Multifamily | Senior Living |  
Student Housing | Military Housing

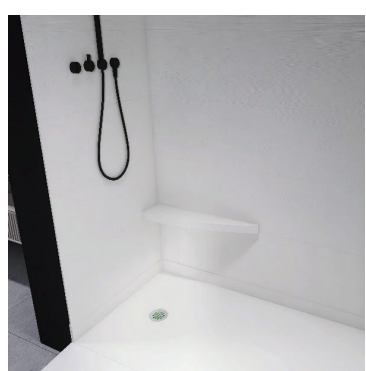

### Standard Features

- Durable gel coat surface
- Pre-levelling-rests on subfloor
- Extremely sanitary
- Will not mold or mildew
- Easy to install
- Maintenance-free
- Standard drain

### Technical Specifications

Model	: Roll-In Shower Pan
Size	: 30" x 60"
Material	: Culture Marble
Floor Pattern	: Traditional
Finish	: Matte, Textured, Non-Slip
Drain Location	: Offset -(specify left or right)
Flange	: 1" on side and backwalls

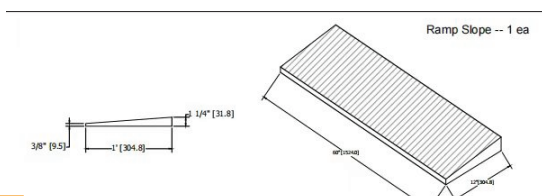
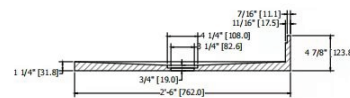
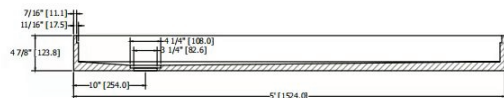
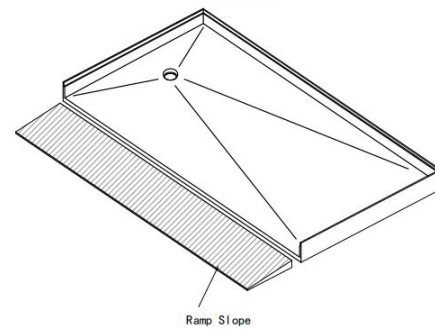
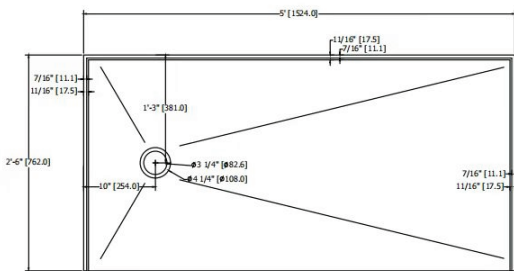

# ACCESSORIES - TRIM

## TR-32

### Recommended Use :

Seam trim for tub and shower panel systems

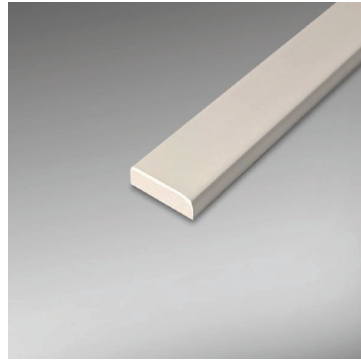

### Standard Features

- Smooth Finish
- Double Radius Edges
- Solid one - piece construction
- Seamless
- Permanently sealed surface
- Extremely sanitary
- Will not mold or mildew
- Easy to install
- Easy to maintain

### Technical Specifications

Model	: TR-32
Material	: Cultured Marble
Size	: 2" wide, 5/16" thick
Finish	: Matte/Gloss

5/16"

2 x R1/16"

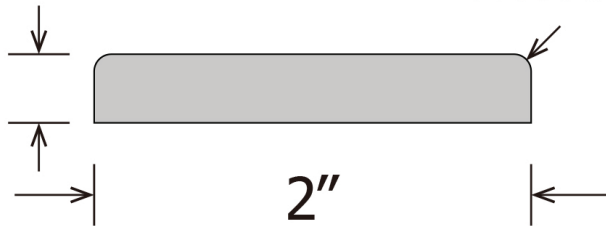

84" or 94" long

2"



# ACCESSORIES - FOOT REST

**FR - 03- 27**  
**FR -03- 30**

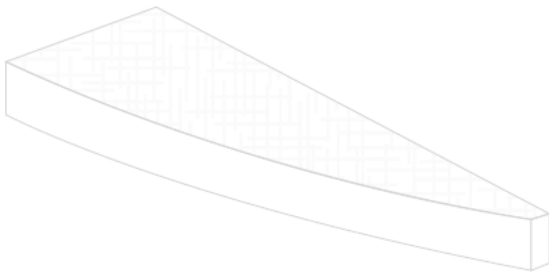

## Standard Features

- Wall-mounted foot rest
- Three pre-drilled mounting holes
- Three -#10 Stainless Steel Truss Head X
- 3" screws - included (to be used with blocking) solid one - piece cast marble
- Durable get coat surface
- Permanently sealed surface
- Will not mold or mildew
- Easy to install
- Maintenance free

## Technical Specifications

Model	: FR - 03- 27	: FR - 03- 30
Type	: Wall Mount	: Wall Mount
Material	: Cultured Marble	: Cultured Marble
Length	: 27"	: 30"
Depth	: 6"- tapers to 1/2"	: 6"- tapers to 1/2"
Radius	: 84 5/8"	: 84 5/8"
Thickness	: 1 1/2"	: 1 1/2"
Weight	: -7#	: -9#
Finish	: Matte/Gloss	: Matte/Gloss

**Special Notes:** 3 MAW 35 - SD Winglt's (to be used when backing unavailable)

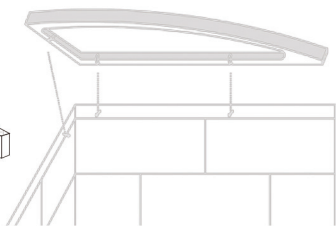
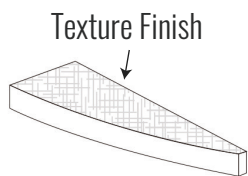

Foot rest has 3 slots fabricated into it for mounting



3" Stainless Steel Screws provided for blocking in the wall

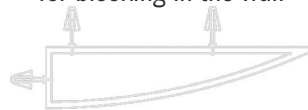

MAW Winglts provided if no blocking

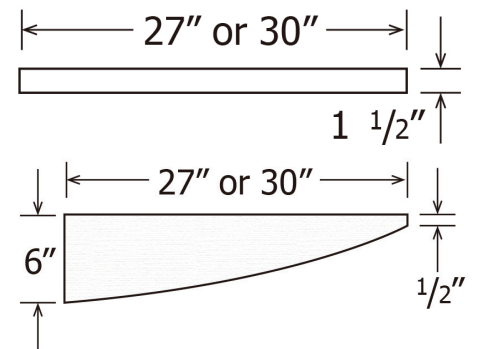

# ACCESSORIES - FOOT REST

## FR - 04

### Finish

Matte

### Standard Features

- Two pre-drilled mounting holes
- Solid one-piece cast marble
- Durable get coat surface
- Permanently sealed surface
- Will not mold or mildew
- Easy to install
- Maintenance-free

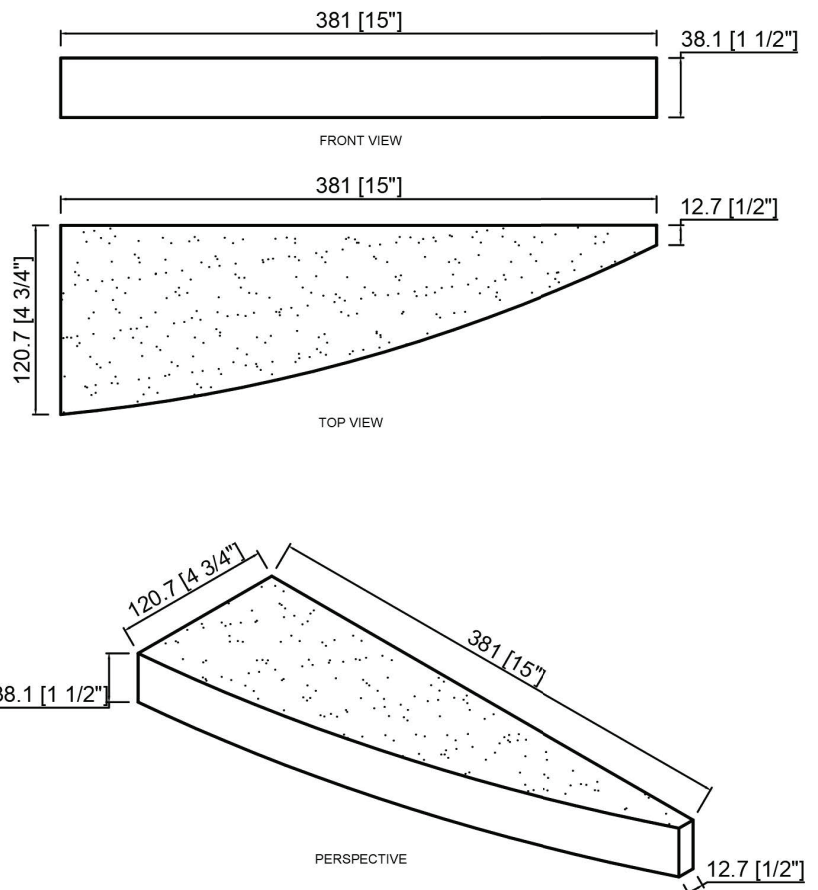
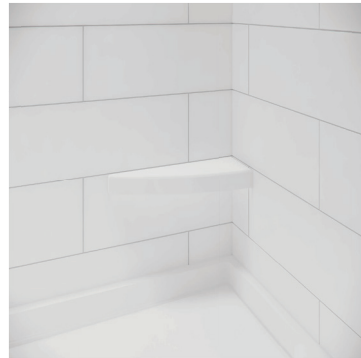

# ACCESSORIES - SHAMPOO DISH

SD - 01



## Standard Features

- Wall-mounted Soap dish
- solid one - piece cast marble
- Permanently sealed surface
- Extremely sanitary
- Will not mold or mildew
- Easy to install
- Easy to maintain

## Technical Specifications

Model	: SD -01
Type	: Wall Mount
Material	: Cultured Marble
Size	: 6 3/4" x 6 3/4" x 2 1/4"
Height	: 2 1/4"
Finish	: Matte/Gloss

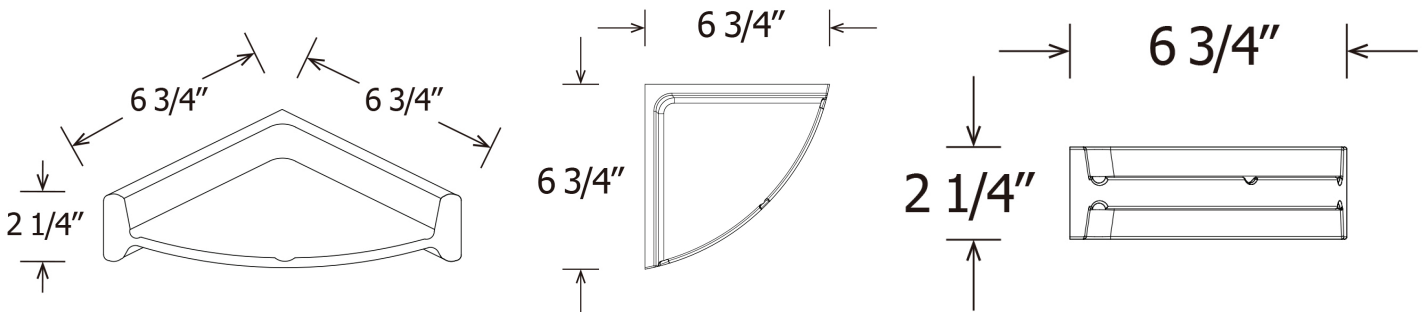

# GLASS DOOR

## Type

Simple Shower Enclosure

## Collection

Diamond

## Series

Raingle

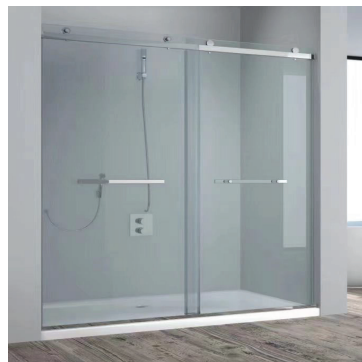

## Specifications

Model No.	: SE-DZ0001
Shape	: 1 Glass Fixed 1 Movable Door
Thickness	: 10mm Nano Glass
Door Open Style	: Sliding Door with 69mm 4 Rollers (40 x 15mm 304 rail)
Handles	: 304 model H20 Mirror Polished
Basement	: No
Sealing Accessories	: Waterproof Strip without Magnetic Seal Strip
Size	: 62"x78" (1574.8x1981.2mm)

## Specifications

Model No.	: SE-ST222-122
Shape	: 2 Movable Doors
Thickness	: 10mm Clear Glass
Door Open Style	: Sliding Doors, ss304, PCS Double Rollers
Fixeture to wall	: No Profile brushed, Mirror Polished
Handles	: H19 as Pictured 2 Handles brushed, Mirror Polished
Basement	: No
Sealing Accessories	: Waterproof Strip , 4pcs Particle Collision
Size	: 62"x78" (1574.8x1981.2mm) Nano Glass, SGCC



# ACCESSORIES - SHAMPOO DISH

SD - 03

## Finish

Matte

Gloss

## Standard Features

- Two stand-off Supports
- Solid one-piece cast marble
- Smooth finish
- Seamless
- Permanently sealed surface
- Extremely sanitary
- Will not mold or mildew

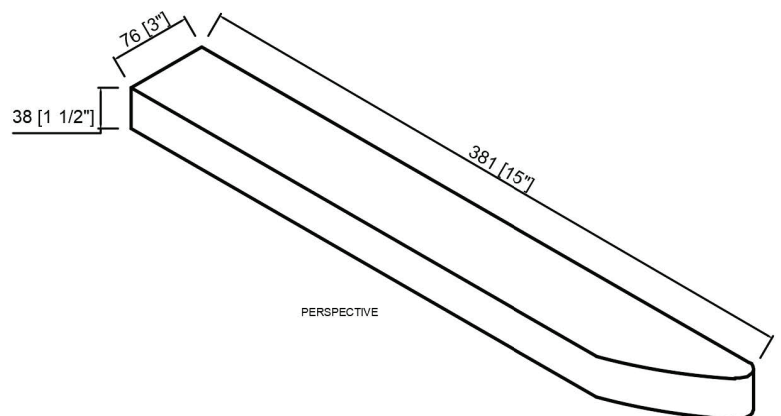
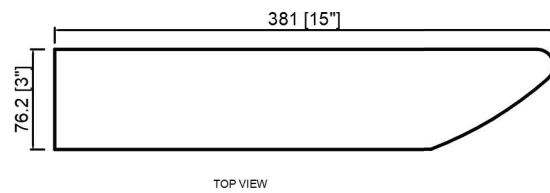
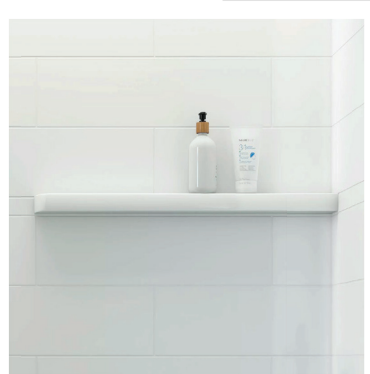

# FAUCET

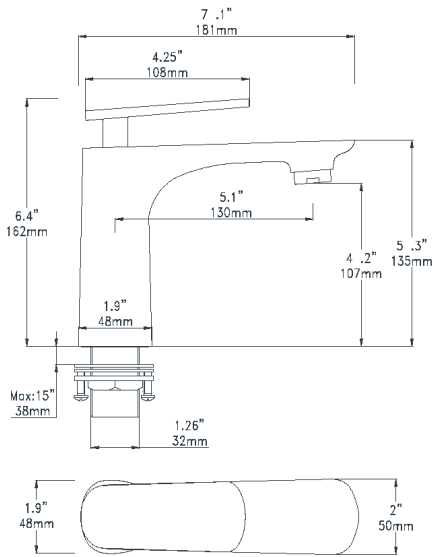

## Specifications

Item No	: CZ 445001-BN
Size	: W7.1"xH6.4"xD1.9"
Working Pressure	: 10psi~80psi
Flow Rate	: 1.5 gpm
PCS/CTN	: 8
Package Size	: 48x38x30cm
Unit Volume	: 0.055
40HQ/PCS	: 9888
Gross Weight	: 14.2kg

## Specifications

Item No	: CZ 445001-CP
Size	: W7.1"xH6.4"xD1.9"
Working Pressure	: 10psi~80psi
Flow Rate	: 1.5 gpm
PCS/CTN	: 8
Package Size	: 48x38x30cm
Unit Volume	: 0.055
40HQ/PCS	: 9888
Gross Weight	: 14.2kg

## Features



Brass



Environmental  
Bars



CRI 80



Wet  
Rated



125psi



66C



Finger  
Free



50,000 th

# FAUCET

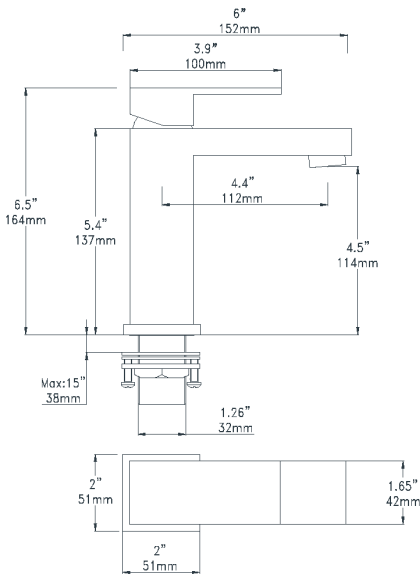

## Specifications

Item No	: CZ 320001-BN
Size	: W6"xH6.5"xD2"
Working Pressure	: 10psi~80psi
Flow Rate	: 1.5 gpm
PCS/CTN	: 10
Package Size	: 42x33x37cm
Unit Volume	: 0.0513
40HQ/PCS	: 11160
Gross Weight	: 17Kg

## Specifications

Item No	: CZ 320001-CP
Size	: W6"xH6.5"xD2"
Working Pressure	: 10psi~80psi
Flow Rate	: 1.5 gpm
PCS/CTN	: 10
Package Size	: 42x33x37cm
Unit Volume	: 0.0513
40HQ/PCS	: 11160
Gross Weight	: 17kg

## Features



Brass



Environmental  
Bars



CRI 80



Wet  
Rated



125psi



66C



Finger  
Free



50,000 th

# FAUCET

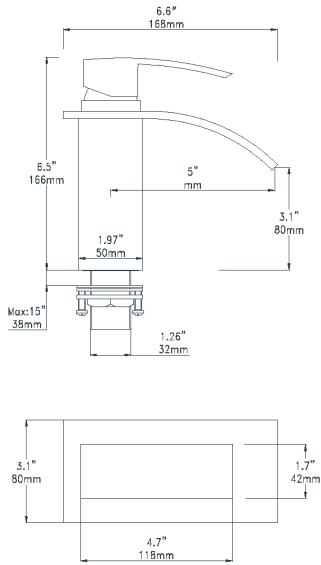

## Specifications

Item No	: CZ 318501-BN
Size	: W6.6"xH6.5"xD3.1"
Working Pressure	: 10psi~80psi
Flow Rate	: 1.5 gpm
PCS/CTN	: 16
Package Size	: 52x38x36cm
Unit Volume	: 0.0711
40HQ/PCS	: 14784
Gross Weight	: 22kg

## Specifications

Item No	: CZ 318501-GP
Size	: W6.6"xH6.5"xD3.1"
Working Pressure	: 10psi~80psi
Flow Rate	: 1.5 gpm
PCS/CTN	: 16
Package Size	: 52x38x36cm
Unit Volume	: 0.0711
40HQ/PCS	: 14784
Gross Weight	: 22kg

## Features



Brass



Environmental  
Bars



CRI 80



Wet  
Rated



125psi



66C



Finger  
Free



50,000 th



# FAUCET

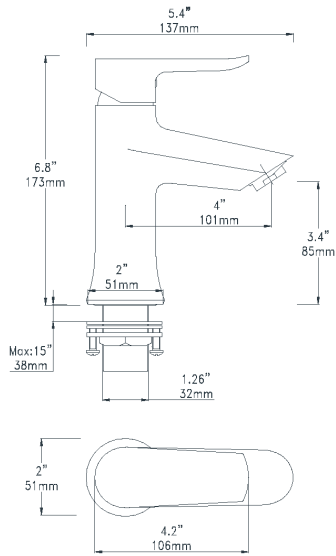

## Specifications

Item No	: CZ 354001-CP
Size	: W5.4"xH6.8"xD2"
Working Pressure	: 10psi~80psi
Flow Rate	: 1.5 gpm
PCS/CTN	: 10
Package Size	: 42x33x37cm
Unit Volume	: 0.0513
40HQ/PCS	: 11160
Gross Weight	: 14kg

## Features



Brass



Environmental  
Bars



CRI 80



Wet  
Rated



125psi



66C



Finger  
Free



50,000 th

# FAUCET

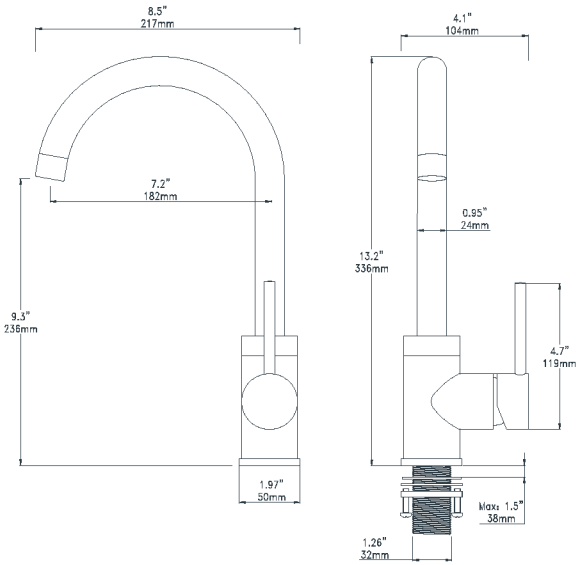

## Specifications

Item No	: CZ 370002-BN
Size	: W8.5"xH13.2"xD4.1"
Working Pressure	: 10psi~80psi
Flow Rate	: 1.5 gpm
PCS/CTN	: 10
Package Size	: 56x48x37cm
Unit Volume	: 0.0995
40HQ/PCS	: 6930
Gross Weight	: 22kg

## Features



Brass



Environmental  
Bars



CRI 80



Wet  
Rated



125psi



66C



Finger  
Free



50,000 th

# FAUCET

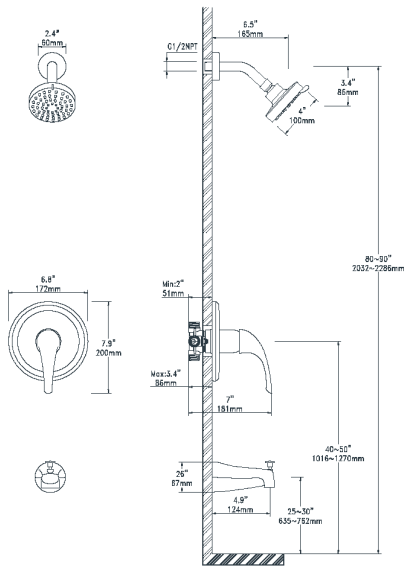

## Specifications

Item No	: CZ 364106-BN
Size	: W7"xH7.9"xD6.8"
Working Pressure	: 10psi~80psi
Flow Rate	: 1.5 gpm
PCS/CTN	: 4
Package Size	: 54x42x35cm
Unit Volume	: 0.0794
40HQ/PCS	: 3136
Gross Weight	: 12Kg
Color	: Chrome Police   Brush Nickle   Matt Black

## Specifications

Item No	: CZ 364106-PC
Size	: W7"xH7.9"xD6.8"
Working Pressure	: 10psi~80psi
Flow Rate	: 1.5 gpm
PCS/CTN	: 4
Package Size	: 54x42x35cm
Unit Volume	: 0.0794
40HQ/PCS	: 3136
Gross Weight	: 12kg
Color	: Chrome Police   Brush Nickle   Matt Black

## Features



Brass



Enviromental  
Barss



CRI 80



Wet  
Rated



125psi



66C



Finger  
Free



50,000 th

## Toilet Paper Roll Holder with Shelf

### Technical Specifications

Model Number	: 8203D-P
Model Name	: Modern Elegance Toilet Paper Roll Holder with Shelf
Color/Finish	: Polished Stainless Steel
Size/Dimensions	: 6.3"W x 4"D x 3.54"H

Notes : Includes Stainless Steel Screws and Plastic Fasteners for Installation.  
To be mounted on wall at convenient position.



## Single Towel Bar

### Technical Specifications

Model Number	: 8208D-P
Model Name	: Modern Elegance Single Towel Bar
Color/Finish	: Polished Stainless Steel
Size/Dimensions	: 24"W x 3.07"D x 3.19"H

Notes : Includes Stainless Steel Screws, covers and Plastic Fasteners for Installation.  
To be mounted on wall at convenient position.



## Towel Shelf with Bar

### Technical Specifications

Model Number	: 8212D-P
Model Name	: Modern Elegance Towel Shelf with Bar
Color/Finish	: Polished Stainless Steel
Size/Dimensions	: 24"W x 8.54"D x 6.89"H

Notes : Includes Stainless Steel Screws, covers and Plastic Fasteners for Installation.  
To be mounted on wall at convenient position.





## Towel Shelves

### Technical Specifications

Model Number : 8111-P

Model Name : Modern Elegance Towel Shelves

Color/Finish : Polished Stainless Steel

Size/Dimensions : 24"

Notes : Includes Stainless Steel Screws, covers and Plastic Fasteners for Installation.  
To be mounted on wall at convenient position



## Curved Shower Rod

### Technical Specifications

Model Number : CC0214-P

Model Name : Modern Elegance Curved Shower Rod 60"

Color/Finish : Polished Stainless Steel + +Chrome Plated Zinc Alloy

Size/Dimensions : 60"

Notes : Includes Stainless Steel Screws and Plastic Fasteners for Installation.  
To be mounted on wall at convenient position.

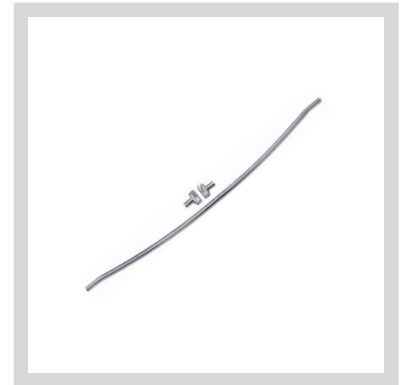

## Round Grab Bar

### Technical Specifications

Model Number : 5302-12P

Model Name : Modern Elegance ø32mm Round Grab Bar 12"

Color/Finish : Polished Stainless Steel

Size/Dimensions : 12"

Notes : Includes Stainless Steel Screws and Plastic Fasteners for Installation.  
To be mounted on wall at convenient position



## Round Grab Bar

### Technical Specifications

Model Number : 5302-24P

Model Name : Modern Elegance ø32mm Round Grab Bar 24"

Color/Finish : Polished Stainless Steel

Size/Dimensions : 24"

Notes : Includes Stainless Steel Screws and Plastic Fasteners for Installation.  
To be mounted on wall at convenient position.



## Round Grab Bar

### Technical Specifications

Model Number : 5302-36P

Model Name : Modern Elegance ø32mm Round Grab Bar 36"

Color/Finish : Polished Stainless Steel + +Chrome Plated Zinc Alloy

Size/Dimensions : 36"

Notes : Includes Stainless Steel Screws and Plastic Fasteners for Installation.  
To be mounted on wall at convenient position.



## Round Grab Bar

### Technical Specifications

Model Number : 5302-42P

Model Name : Modern Elegance ø32mm Round Grab Bar 42"

Color/Finish : Polished Stainless Steel

Size/Dimensions : 42"

Notes : Includes Stainless Steel Screws and Plastic Fasteners for Installation.  
To be mounted on wall at convenient position.



## Toilet Paper Roll Holder with Shelf

### Technical Specifications

Model Number	: 8203D-S
Model Name	: Modern Elegance Toilet Paper Roll Holder with Shelf
Color/Finish	: Brushed Stainless Steel
Size/Dimensions	: 6.3"W x 4"D x 3.54"H

Notes : Includes Stainless Steel Screws and Plastic Fasteners for Installation.  
To be mounted on wall at convenient position.



## Single Towel Bar

### Technical Specifications

Model Number	: 8208D-S
Model Name	: Modern Elegance Single Towel Bar
Color/Finish	: Brushed Stainless Steel
Size/Dimensions	: 24"W x 3.07"D x 3.19"H

Notes : Includes Stainless Steel Screws, covers and Plastic Fasteners for Installation.  
To be mounted on wall at convenient position.



## Towel Shelf with Bar

### Technical Specifications

Model Number	: 8212D-S
Model Name	: Modern Elegance Towel Shelf with Bar
Color/Finish	: Brushed Stainless Steel
Size/Dimensions	: 24"W x 8.54"D x 6.89"H

Notes : Includes Stainless Steel Screws, covers and Plastic Fasteners for Installation.  
To be mounted on wall at convenient position.



## Toilet Paper Roll Holder

### Technical Specifications

Model Number : ZC03-BN

Model Name : Modern Elegance Toilet Paper Roll Holder

Color/Finish : Brushed Nickel Zinc Alloy+ Brushed Stainless Steel

Size/Dimensions : 8.07"W x 3.54"D x 1.85"H

Notes : Includes Stainless Steel Screws and Plastic Fasteners for Installation.  
To be mounted on wall at convenient position.



## Towel Ring

### Technical Specifications

Model Number : ZC04-BN

Model Name : Modern Elegance Towel Ring

Color/Finish : Brushed Nickel Zinc Alloy+ Brushed Stainless Steel

Size/Dimensions : 6.3"W x 3.54"D x 7.09"H

Notes : Includes Stainless Steel Screws and Plastic Fasteners for Installation.  
To be mounted on wall at convenient position.



## Single Towel Bar

### Technical Specifications

Model Number : ZC8-24BN

Model Name : Modern Elegance Single Towel Bar

Color/Finish : Brushed Nickel Zinc Alloy+ Brushed Stainless Steel

Size/Dimensions : 24"W x 3.54"D x 1.85"H

Notes : Includes Stainless Steel Screws and Plastic Fasteners for Installation.  
To be mounted on wall at convenient position.





## Towel Shelves

### Technical Specifications

Model Number : 8111-S

Model Name : Modern Elegance Towel Shelves

Color/Finish : Brushed Stainless Steel

Size/Dimensions : 24"

Notes : Includes Stainless Steel Screws, covers and Plastic Fasteners for Installation.  
To be mounted on wall at convenient position.

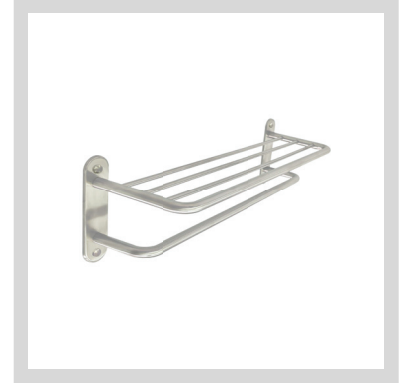

## Curved Shower Rod

### Technical Specifications

Model Number : CC0214-BN

Model Name : Modern Elegance Curved Shower Rod

Color/Finish : Brushed Stainless Steel +Nickel Brushed Zinc Alloy

Size/Dimensions : 60"

Notes : Includes Stainless Steel Screws and Plastic Fasteners for Installation.  
To be mounted on wall at convenient position.

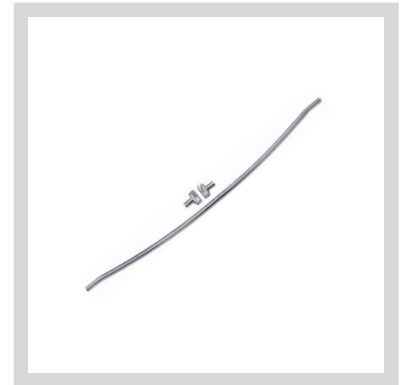

## Round Grab Bar

### Technical Specifications

Model Number : 5302-12S

Model Name : Modern Elegance ø32mm Round Grab Bar 12"

Color/Finish : Brushed Stainless Steel

Size/Dimensions : 12"

Notes : Includes Stainless Steel Screws and Plastic Fasteners for Installation.  
To be mounted on wall at convenient position



## Round Grab Bar

### Technical Specifications

Model Number	: 5302-24S
Model Name	: Modern Elegance ø 32mm Round Grab Bar 24"
Color/Finish	: Brushed Stainless Steel
Size/Dimensions	: 24"

Notes : Includes Stainless Steel Screws and Plastic Fasteners for Installation.  
To be mounted on wall at convenient position.



## Round Grab Bar

### Technical Specifications

Model Number	: 5302-36S
Model Name	: Modern Elegance ø 32mm Round Grab Bar 36"
Color/Finish	: Brushed Stainless Steel
Size/Dimensions	: 36"

Notes : Includes Stainless Steel Screws and Plastic Fasteners for Installation.  
To be mounted on wall at convenient position.



## Round Grab Bar

### Technical Specifications

Model Number	: 5302-42S
Model Name	: Modern Elegance ø32mm Round Grab Bar 42"
Color/Finish	: Brushed Stainless Steel
Size/Dimensions	: 42"

Notes : Includes Stainless Steel Screws and Plastic Fasteners for Installation.  
To be mounted on wall at convenient position



# ACCESSORIES

## Toilet Paper Roll Holder

### Technical Specifications

Model Number	: ZC03-CP
Model Name	: Modern Elegance Toilet Paper Roll Holder
Color/Finish	: Chrome Plated Zinc Alloy + Polished Stainless Steel
Size/Dimensions	: 8.07"W x 3.54"D x 1.85"H

Notes : Includes Stainless Steel Screws and Plastic Fasteners for Installation.  
To be mounted on wall at convenient position.



## Round Grab Bar

### Technical Specifications

Model Number	: ZC04-CP
Model Name	: Modern Elegance Towel Ring
Color/Finish	: Chrome Plated Zinc Alloy + Polished Stainless Steel
Size/Dimensions	: 6.3"W x 3.54"D x 7.09"H

Notes : Includes Stainless Steel Screws and Plastic Fasteners for Installation.  
To be mounted on wall at convenient position.



## Single Towel Bar

### Technical Specifications

Model Number	: ZC8-24CP
Model Name	: Modern Elegance 24" Single Towel Bar
Color/Finish	: Chrome Plated Zinc Alloy+ Polished Stainless Steel
Size/Dimensions	: 24"W x 3.54"D x 1.85"H

Notes : Includes Stainless Steel Screws and Plastic Fasteners for Installation.  
To be mounted on wall at convenient position



## Double Robe Hook

### Technical Specifications

Model Number : ZC836-6

Model Name : Modern Elegance Double Robe Hook

Color/Finish : Chromed Zinc Alloy

Size/Dimensions : 2.54"W x 1.54"D x 1.44"H

Notes : Includes Stainless Steel Screws and Plastic Fasteners for Installation.  
To be mounted on wall at convenient position.



## Toilet Paper Roll Holder with Shelf

### Technical Specifications

Model Number : 8203D-MB

Model Name : Modern Elegance Toilet Paper Roll Holder with Shelf

Color/Finish : Powder Coated Matt Black Stainless Steel

Size/Dimensions : 6.3"W x 4"D x 3.54"H

Notes : Includes Stainless Steel Screws and Plastic Fasteners for Installation.  
To be mounted on wall at convenient position.



## Single Towel Bar

### Technical Specifications

Model Number : 8208D-MB

Model Name : Modern Elegance Single Towel Bar

Color/Finish : Powder Coated Matt Black Stainless Steel

Size/Dimensions : 24"W x 3.07"D x 3.19"H

Notes : Includes Stainless Steel Screws and Plastic Fasteners for Installation.  
To be mounted on wall at convenient position



# ACCESSORIES

## Towel Shelf with Bar

### Technical Specifications

Model Number : 8212D-MB

Model Name : Modern Elegance Towel Shelf with Bar

Color/Finish : Powder Coated Matt Black Stainless Steel

Size/Dimensions : 24"W x 8.54"D x 6.89"H

Notes : Includes Stainless Steel Screws and Plastic Fasteners for Installation.  
To be mounted on wall at convenient position.



## Curved Shower Rod

### Technical Specifications

Model Number : CC0214-MB

Model Name : Modern Elegance Curved Shower Rod 60"

Color/Finish : Powder Coated Matt Black Stainless Steel and Zinc Alloy

Size/Dimensions : 60"

Notes : Includes Stainless Steel Screws and Plastic Fasteners for Installation.  
To be mounted on wall at convenient position.

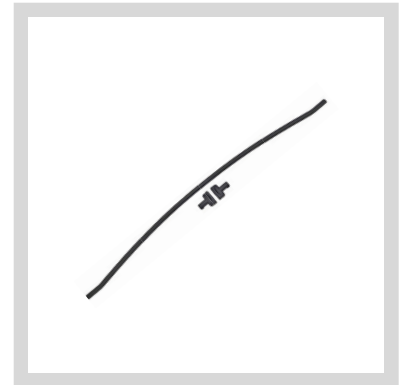

## Toilet Paper Holder

### Technical Specifications

Model Number : 4003-MB

Model Name : Modern Elegance Toilet Paper Holder

Color/Finish : Powder Coated Matt Black Stainless Steel

Size/Dimensions : 6.1"W x 3.15"D x 5.91"H

Notes : Includes Stainless Steel Screws and Plastic Fasteners for Installation.  
To be mounted on wall at convenient position





## Single Towel Bar

### Technical Specifications

Model Number : 4008-MB

Model Name : Modern Elegance Single Towel Bar 24"

Color/Finish : Powder Coated Matt Black Stainless Steel

Size/Dimensions : 24"W x 2.76"D x 1.97"H

Notes : Includes Stainless Steel Screws and Plastic Fasteners for Installation.  
To be mounted on wall at convenient position.



## Towel Rack

### Technical Specifications

Model Number : 4012-MB

Model Name : Modern Elegance Towel Rack 24"

Color/Finish : Powder Coated Matt Black Stainless Steel

Size/Dimensions : 24"W x 8.27"D x 4.72"H

Notes : Includes Stainless Steel Screws and Plastic Fasteners for Installation.  
To be mounted on wall at convenient position.



## Grab Bar

### Technical Specifications

Model Number : LC5302--12MB

Model Name : Modern Elegance ø32mm Grab Bar 12"

Color/Finish : Powder Coated Matt Black Stainless Steel

Size/Dimensions : 12"

Notes : Includes Stainless Steel Screws and Plastic Fasteners for Installation.  
To be mounted on wall at convenient position



# ACCESSORIES

## Grab Bar

### Technical Specifications

Model Number : LC5302--24MB

Model Name : Modern Elegance ø32mm Grab Bar 24"

Color/Finish : Powder Coated Matt Black Stainless Steel

Size/Dimensions : 24"

Notes : Includes Stainless Steel Screws and Plastic Fasteners for Installation.  
To be mounted on wall at convenient position.



## Grab Bar

### Technical Specifications

Model Number : LC5302--36MB

Model Name : Modern Elegance ø32mm Grab Bar 36"

Color/Finish : Powder Coated Matt Black Stainless Steel

Size/Dimensions : 36"

Notes : Includes Stainless Steel Screws and Plastic Fasteners for Installation.  
To be mounted on wall at convenient position.



## Grab Bar

### Technical Specifications

Model Number : LC5302--42MB

Model Name : Modern Elegance ø32mm Grab Bar 42"

Color/Finish : Powder Coated Matt Black Stainless Steel

Size/Dimensions : 42"

Notes : Includes Stainless Steel Screws and Plastic Fasteners for Installation.  
To be mounted on wall at convenient position





**USA HOSPITALITY**  
**BATH & FLOOR**

**THANK  
YOU!**

**Address**

25400 Industrial Park Road, Ardmore, TN 38449

**Phone**

Parth Patel: (938) - 310 - 8137 | Striker Patel: (938) - 310 - 8136

**E-mail**

[bathsupply@usahospitalitytn.com](mailto:bathsupply@usahospitalitytn.com)

[www.usahospitalitytn.com](http://www.usahospitalitytn.com)