



P/N: AST-S-G11-300WCT3A1-abcdef

The letter "a" can be any two letters to represent lamp colors; "BH = Black \ WH = White \ BR = Brown or Customized

The letter "b" represent photocontrol, which can be "3RP", "3NP", "5RP", "5NP", "7RP", "7NP" for Photocontrol type provided or blank for no Photocontrol provided.

The letter "c" represent surge protector, can be "10SP", "20SP" for Surge-Protective Device type provided or blank for no Surge-Protective Device provided.

The letter "d" can be "M" or blank for Motion Sensor provided or not.

The letter "e" represent bracket, can be "AM", "DM", "YM", "A&DM" and "FM" or not.

The letter "f" can be any two digits to represent CCT.



AM



DM

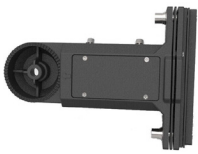

A&D



YM

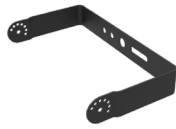

FM

DIMENSIONS

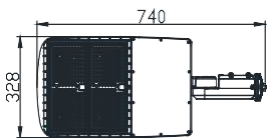

A&D

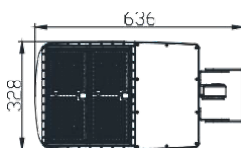

YM

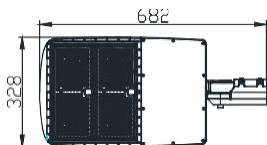

AM

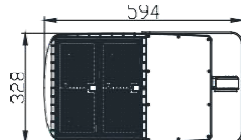

FM

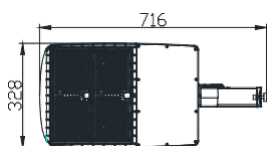

DM

Advantage:

- UL cUL DLC certificate.
- Seoul Chip, high CRI
- IP65 driver, Input voltage 100-277Vac
- Output constant current lever can be adjusted through output cable with 1-10V.
- No UV or IR in the beam
- Easy to install and operate
- Energy saving, Long lifespan
- Light is soft and uniform, Safe to eyes
- Instant start, NO flickering, NO humming
- Green and eco-friendly without mercury.

Application:

- Outdoor basketball court, tennis court.
- Badminton court, the football field.
- The school playground, stadium.
- Community leisure entertainment plaza, road lamp etc.

SPECIFICATIONS

OPTICAL	Input Power	300W
	Lumen	39000-42000LM
	Lumen Efficacy	130-140 LM/W
	Color Temperature	4000K, 5000K, 5700K
	CRI	>70
	Viewing Angle	160*96 Degree (Type III)
ELECTRICAL	Input Voltage	100-277VAC 50/60Hz
	PF	≥0.9
	THD	≤20%
	Driver Model	SOSEN SS-150VA-56B*2
	Optional Accessory	Photocell / Surge protector/ Motion sensor/Socket
MATERIALS	LED Brand	Seoul
	LED Type	3030
	LED QTY	378PCS
	Housing	Aluminum Alloy
	Housing Color	Black / Brown/white/Customized
	Waterproof Rating	WET (IP65)
OTHERS	Operating Temperature	-40°C TO 50°C
	Operating Humidity	10%-90% RH
	Storage Temperature	-40°C TO 80°C
	Storage Humidity	10%-95% RH
	Warranty Time	5 Years

PACKAGE

Stent Type	Lamps Net Weight	Size	Qty/ Carton	Weight/ Carton
AM	7.6Kg	755*375*160MM	1	9.0Kg
DM	8.2Kg	755*375*160MM	1	9.6Kg
YM	7.7Kg	755*375*160MM	1	8.7Kg
A&D	8.2Kg	755*375*160MM	1	9.9Kg
FM	8.1Kg	755*375*160MM	1	9.5Kg

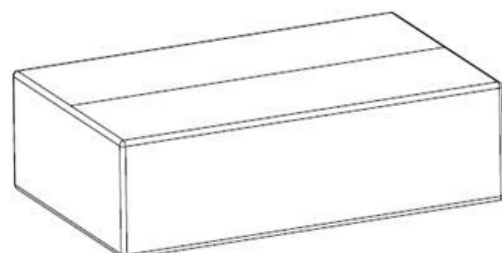
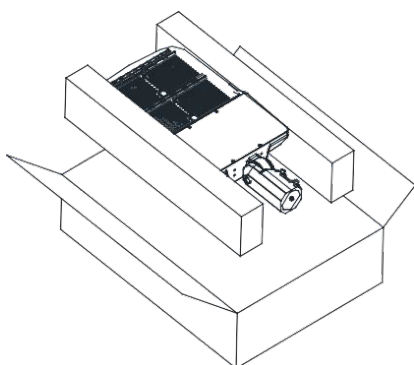

LIGHT DISTRIBUTION TESTING PARAMETERS

Luminaire Property

Luminaire Manufacturer:

Voltage: 120.1 V

Power: 299.17 W

Current: 2.496 A

Power Factor: 0.998

Photometric Results

IES Classification: Type III

Total Rated Lamp Lumens: 39716.7 lm

Efficiency: 100%

Upward Ratio: 0%

Central Intensity: 241.79 cd/klm

Pos of Max. Intensity: H10 V69

Longitudinal Classification: Medium

Measurement Flux: 39716.7 lm

Downward Ratio: 100%

Luminaire Efficacy Rating (LER): 132.81

Max. Intensity: 357.9 cd/klm

Luminous Intensity Distribution Curve

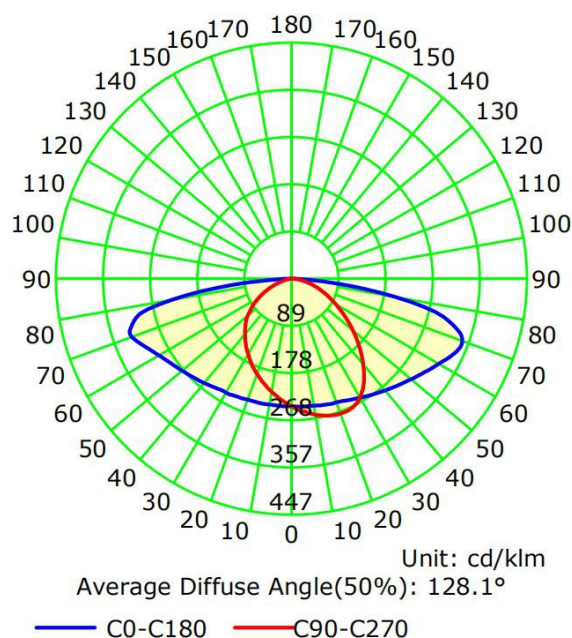

Illuminance at a Distance

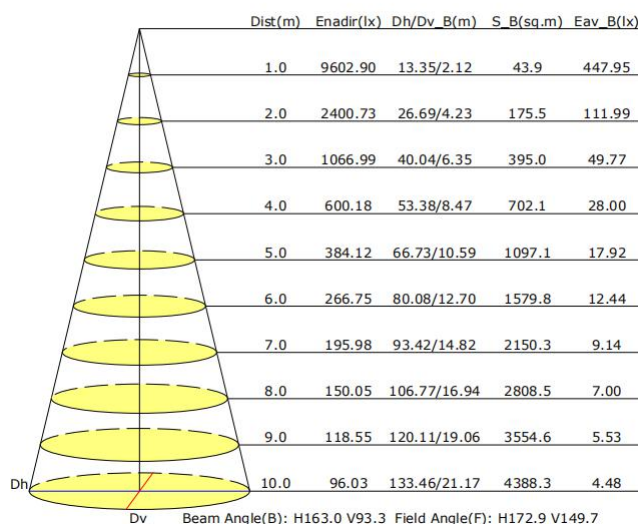

NOTICE FOR USER

- Please turn off power before install or change assembly parts.
- The input voltage and lamps should be matched, after connecting the power line, Please make sure the wiring section is insulated.
- No-professionals, must not install and disassemble the lamps.

TROUBLE SHOOTINGS

Troubles	Check points
Flickering of the light	Turn off the power and turn on again in 3 minutes. If same phenomena occur, then call agencies.
Out of working	Please check the connection.